



Das Original







VSI 01/10

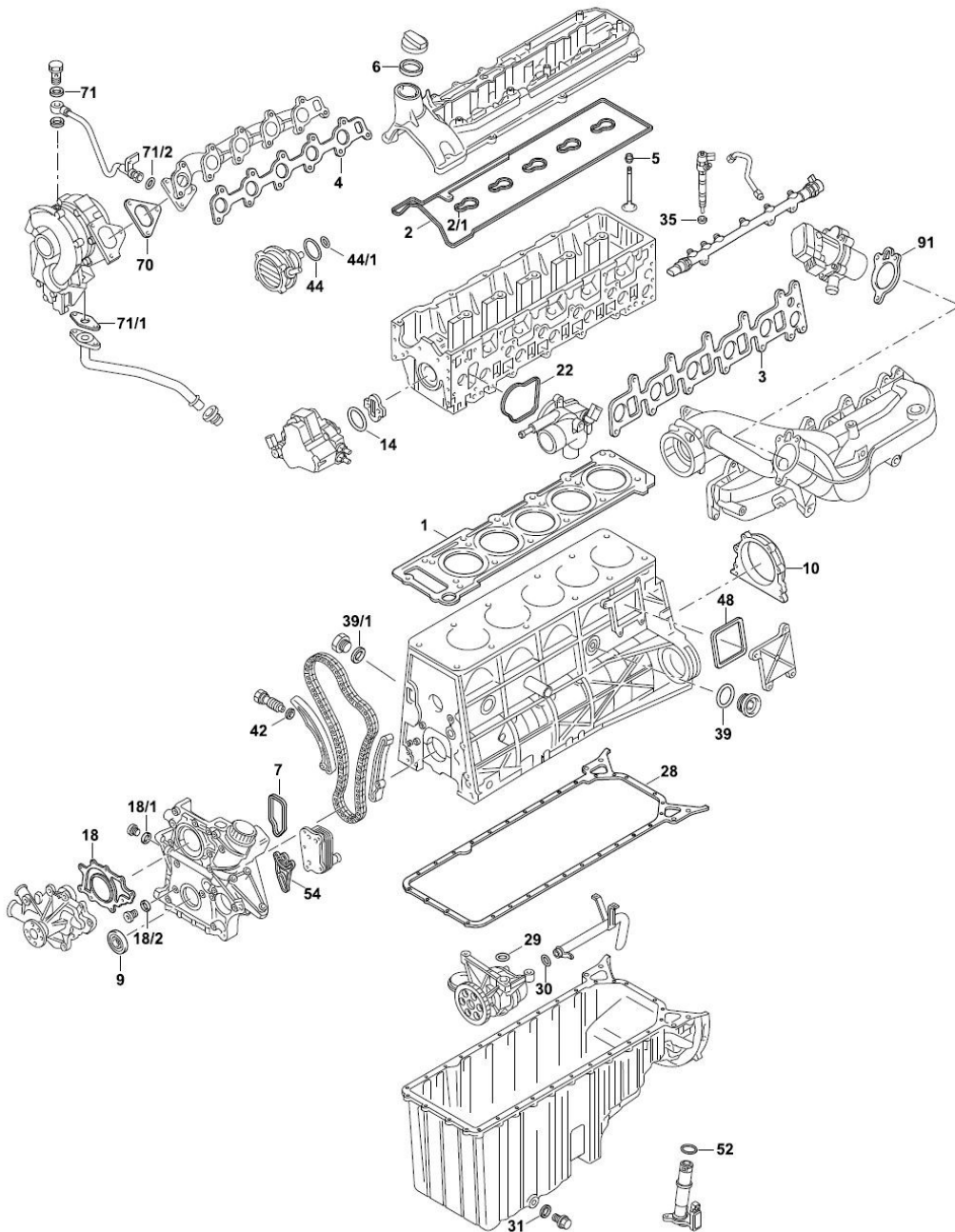

Neu

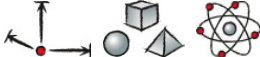
Mercedes-Benz | Dodge | Freightliner Sprinter OM 647.981



			#		
S ⊕ *	381.150	1x	–	–	
ES ⊕	685.500	1x	–	–	
CS *	633.330	1x	612 010 14 05	–	–
VAS	687.510	1x	–	–	–
ZKHS	685.330	1x	–	–	–
ZKS	760.120	1x	–	–	–
1	762.821	1x	647 016 06 20	1,20 mm 88,8 Ø	–
1	612.332	1x	647 016 07 20	1,40 mm 88,8 Ø	–
1	376.390	1x	647 016 13 40	1,20 mm 89,3 Ø	–
1	376.400	1x	647 016 14 20	1,40 mm 89,3 Ø	–
2	a.A.	1x	647 016 01 21	–	–
2/1	a.A.	5x	646 016 13 21	–	–
3	433.112	1x	612 141 01 80	–	–
4	432.924	1x	612 142 03 80	–	–
5	830.489	20x	000 053 41 58	FPM	E/A
6	a.A.	1x	111 018 00 80	47,5x59x2,3 HNBR A	–
7	356.140	1x	611 015 01 80	Metall-Elastomer	–
9	424.841	1x	021 997 76 47 023 997 84 47	ASW RD PTFE 45x67x8	–
10	746.400	1x	611 010 02 14	SD LD PTFE 93 Ø	–
14	503.030	1x	012 997 07 45	44x3,0 FPM	–
18	365.360	1x	611 201 02 80	–	–
18/1	250.007	1x	007603 022100	22x27x1,5 AL A	–
18/2	235.253	1x	007603 010100	10x13,5x1 AL A	–
22	a.A.	1x	611 203 03 80	–	–
28	490.653	1x	647 014 00 22	–	–
29	294.430	1x	019 997 80 48	16x3 FPM	–
30	003.360	1x	027 997 38 48	22x4 FPM	–
31	115.100	1x	007603 014106	14x20x1,5 CU A	–
35	924.867	5x	611 017 00 60	7,1x15x1,56 CU D	–
35	199.360	5x	611 017 03 60	7,1x15x1,76 CU D	Reparaturgröße repair size taille de réparation dimension de la reparación taglie di riparazione
35	199.340	5x	611 017 04 60	7,1x15x1,96 CU D	Reparaturgröße repair size taille de réparation dimension de la reparación taglie di riparazione
39	a.A.	1x	006 997 75 48	36,5x40,5x2 NBR RD	–
39/1	a.A.	1x	007603 012113	12x17x1,5 AL A	–
42	a.A.	1x	112 997 00 44	26,7x31,9x2 AL PR	–
44	a.A.	1x	611 997 07 45	53x2,0 FPM	–
44/1	a.A.	1x	668 997 01 45	–	–
48	a.A.	1x	611 159 04 80	EPDM PR	–
52	a.A.	1x	024 997 70 48	30,4x34,8x2,2 FPM RD	–
54	633.540	1x	611 184 02 80	ACM PR	–
70	006.580	1x	646 142 00 80	–	–
71	a.A.	2x	007603 010406	10x15x1 CU A	–
71/1	122.710	1x	611 187 06 80	–	–
71/2	633.510	1x	023 997 85 48	7,8x14,2x3,2 ACM	–
91	a.A.	1x	647 142 00 80	–	–